



Model: 5001

INSTALLATION AND OPERATING INSTRUCTIONS

IF YOU CANNOT READ OR UNDERSTAND THESE INSTALLATION INSTRUCTIONS DO NOT ATTEMPT TO INSTALL OR OPERATE

INTRODUCTION

This SKYTECH remote control system was developed to provide a safe, reliable, and user-friendly remote control system for gas heating appliances. The system can be operated manually from the transmitter. The system operates on radio frequencies (RF) within a 20-foot range using non-directional signals. The system operates one of 1,048,576 security codes that are programmed into the transmitter at the factory; the remote receiver's code must be matched to that of the transmitter prior to initial use.

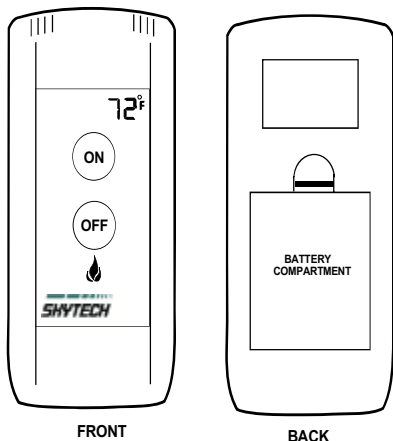

The transmitter operates on 4 AAA-size 1.5V batteries. It is recommended that ALKALINE batteries always be used for longer battery life and maximum operational performance. **IMPORTANT:** New or fully charged batteries are essential for proper operation of the multi-function transmitter. Insert 4 AAA-size 1.5 V batteries into the battery compartment on the back of the transmitter, positioning the (+) and (-) ends of the batteries as indicated on the casing. When the batteries are inserted, the screen at right (with similar numbers) will display.

Note: On initial start up if a LOW battery icon appears on the screen, check the position of the batteries.

Note: Due to the sensitive temperature-monitoring components in the transmitter, it may be necessary to allow the transmitter to stabilize to room temperature before accurate room temperatures are displayed on the screen. If the transmitter is activated from a severe cold condition, it can take up to fifteen minutes for accurate temperature readings to appear.

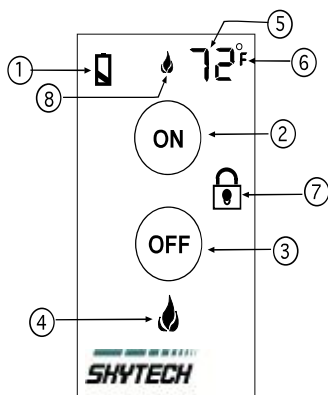
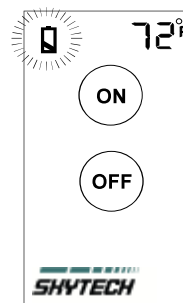

1. **BATTERY ICON** - Battery power is low. Replace batteries within two weeks.
2. **ON**- Indicates the appliance is ON – Flame Icon
3. **OFF**- Indicates the appliance is OFF – NO Flame Icon
4. **FLAME** – Indicates burner/valve in operation.
5. **ROOM** – Indicates CURRENT room temperature.
6. ^o F indicates degrees Fahrenheit (^oC indicates degrees Celsius).
7. **LOCK** – Child lock out.
8. **RF SIGNAL ICON** –Appears when the RF signal is being transmitted.

OPERATION FUNCTIONS

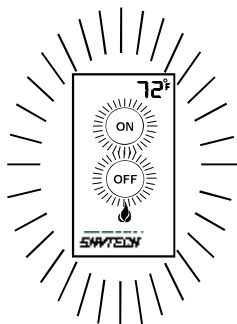

1. Touch anyplace on the screen and the screens blue back light will light up and stay on for (5) seconds.
2. Touch the ON button on the LCD screen front of the transmitter to turn the appliance ON.
3. Touch the OFF button on the LCD screen front of the transmitter to turn the appliance OFF.

SETTING ° F / ° C SCALE

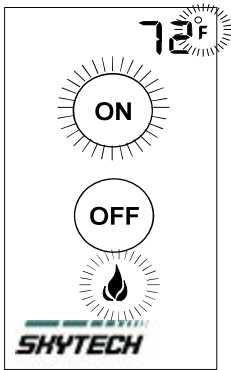

The factory setting for temperature is ° F. To change this setting to ° C, first press and hold the **ON** button and the **FLAME ICON** on the transmitter LCD screen at the same time for (5) seconds. Follow this same procedure to change from ° C back to ° F.

CHILDPROOF “LOCK-OUT”

This remote control includes a CHILDPROOF “LOCK-OUT” feature that allows the user to “LOCK-OUT” operation of the appliance from the TRANSMITTER when it is in the “LOCK OUT” mode.

SETTING “LOCK-OUT”

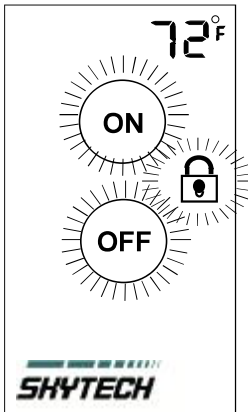

1. To activate the “LOCK-OUT” feature, press and hold the ON and OFF icons on the LCD screen together, for 5 seconds. The lock icon will appear on the LCD screen.
2. To disengage the “LOCK-OUT”, press and hold the ON and OFF icons on the LCD screen together, for 5 seconds. The lock icon will disappear on the LCD screen and the system will return to its normal operating condition.

NOTE: If the appliance is already operating in the ON mode engaging the “LOCK-OUT” will not cancel the operating MODE. Engaging the “LOCK-OUT” prevents only the manual operation of the TRANSMITTER

RECEIVER

The remote receiver operates on 4 AA-size 1.5V batteries. It is recommended that ALKALINE batteries be used for longer battery life and maximum microprocessor performance. **IMPORTANT:** New or fully charged batteries are essential for proper operation of the remote receiver.

The remote receiver houses the microprocessor that responds to commands from the transmitter to control system operation. The remote receiver has a 3-position slide switch for selecting the MODE of operation: ON/REMOTE/OFF

- With the slide switch in the ON position (toward the LEARN button), the system will remain on until the slide switch is placed in the OFF or REMOTE position.
- With the slide switch in the REMOTE position (centered), the system will only operate if the remote receiver receives commands **from the transmitter**.
- With the slide switch in the OFF position (away from the LEARN button), the system is off.
- **It is suggested that the slide switch be placed in the off position if you will be away from your home for an extended period of time. If the remote receiver is mounted out of children’s reach, placing the slide switch in the OFF position also functions as a safety “lock-out” by both turning the system off and rendering the remote receiver inoperative.**

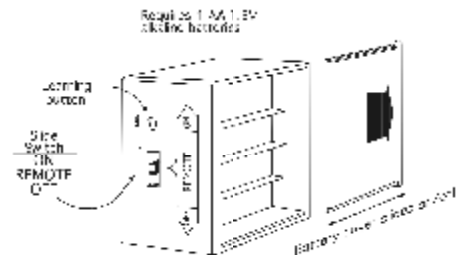

INSTALLATION

The remote receiver can be either wall-mounted in a standard plastic switch box or placed on or near the fireplace hearth. Preferably, the remote receiver should be wall-mounted in a plastic switch box, as this will protect its electronic components from both the heat produced by the gas appliance and potential damage or abuse that can occur if it is left exposed on the hearth. **PROTECTION FROM EXTREME HEAT IS VERY IMPORTANT.** Like any piece of electronic equipment, the remote receiver should be kept away from temperatures exceeding 130° F inside the receiver case. Battery life is also significantly shortened if batteries are exposed to high temperatures. Make sure the remote receiver switch is in the OFF position. It is recommended that 18 gauge solid or stranded wires (included) be used to make connections between the terminal wiring block on the millivolt gas valve or electronic module and the wire terminals on the remote receiver. For the best results, use 18-gauge solid or stranded wire, with no splices and measuring no longer than 20 feet.

WALL MOUNTING

Install 4 AA-size 1.5 ALKALINE batteries in the remote receiver. For best performance, remote receiver batteries should be factory fresh when installed. Very little battery power is required to operate the remote receiver, but the electronics are tuned to operate best when battery output is greater than 5.3 volts. Four new AA batteries should provide an output voltage of 6.0 to 6.2 volts. **Be sure batteries are installed with the (+) and (-) ends facing the correct direction.**

To attach Cover Plate to Receiver box

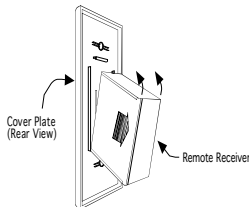

Position the receiver as shown in diagram to the left with lower tab on cover plate inserted into groove of receiver (Make sure the LEARN hole on cover plate properly aligns with remote receiver) Pull Receiver up and snap into top tab of cover plate.

Position the cover plate so the word ON is facing up; then, install the remote receiver into the plastic switch box using the two long screws provided. Push the White Button over the receiver slide switch only after making sure the remote receiver has LEARNED the transmitter's security code (see LEARNING TRANSMITTER TO RECEIVER section).

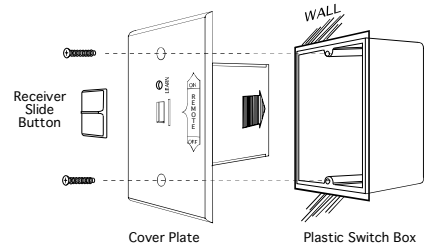

NOTE: The remote receiver will only respond to the transmitter when the 3-position slide button on the remote receiver is in the REMOTE position. If the system does not respond to the battery transmitter on initial use, see LEARNING TRANSMITTER TO RECEIVER, and recheck battery positions in the remote receiver.

HEARTH MOUNT

The remote receiver can be placed on the fireplace hearth or under the fireplace, behind the control access panel. Position where the ambient temperature inside the receiver case does not exceed 130° F.

NOTE: Black Slide Button is used for Hearth Mount applications.

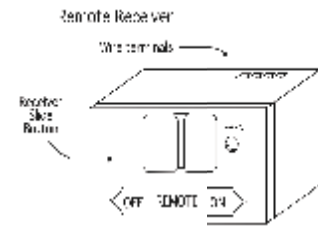

WIRING INSTRUCTIONS

A qualified electrician or a gas technician who is familiar with the gas appliance and gas valves that will be operated by this remote should install the remote control system. Incorrect wiring connections **WILL** cause damage to the gas valve or electronic module operating the gas appliance and may also damage the remote receiver.

WIRING MILLIVOLT VALVES

The remote receiver is connected to the millivolt valve using the TH (thermostat) terminals on the terminal block on the millivolt gas valve. Connect 18 gauge solid or stranded wires from the remote receiver to the gas valve.

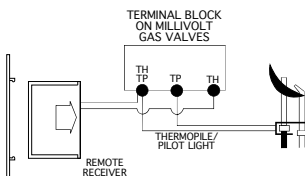

Operation of the remote receiver is similar to that of a thermostat in that both turn the gas valve on and off based on input signals. A thermostat's input signals are different temperatures. The remote receiver's input signals come from the transmitter.

Connect each of the two wires leading from the TH terminals on the millivolt gas valve to either of the two wire terminals on the remote receiver. Normally it does not matter which wires go to which terminal.

WIRING ELECTRONIC SPARK IGNITIONS

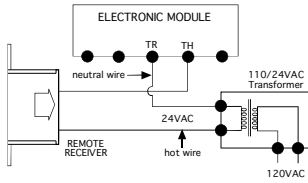

The remote control receiver can be connected, in series, to a 24VAC transformer to the TR (transformer) terminal on the ELECTRONIC MODULE. Connect the hot wire from the 24VAC transformer to either of the wire terminals on the remote receiver. Connect another wire (included) between the other receiver wire terminal and the TH (thermostat) terminal on the ELECTRONIC MODULE.

WARNING

This remote control system must be installed exactly as outlined in these instructions. Read all instructions completely before attempting installation. Follow instructions carefully during installation. Any modifications of the SKYTECH remote control or any of its components will void the warranty and may be pose a fire hazard.

Do not connect any gas valve or electronic module directly to 110-120VAC power. Consult gas appliance manufacturer's instructions and wiring schematics for proper placement of all wires. All electronic modules are to be wired to manufacturer's specifications.

The following wiring diagrams are for illustration purpose only. Follow instructions from manufacturer of gas valve and/or electronic module for correct wiring procedures. Improper installation of electric components can cause damage to electronic module, gas valve and remote receiver.

SYSTEM CHECK

MILLIVOLT VALVES

Light your gas appliance following the lighting instructions that came with the appliance. Confirm that the pilot flame is on; it must be in operation for the main gas valve to operate.

- Slide the 3-position button on the remote receiver to the ON position. The main gas flame (i.e., the fire) should ignite.
- Slide the button to OFF. The flame should extinguish (the pilot flame will remain on).
- Slide the button to REMOTE (the center position), then press the ON button on the transmitter to change the system to ON. The main gas flame should ignite.

ELECTRONIC IGNITION SYSTEMS

- Slide the 3-position button on the remote receiver to the ON position. The spark electrode should begin sparking to ignite the pilot (the pilot may ignite after only one spark). After the pilot flame is lit, the main gas valve should open and the main gas flame should ignite.
- Slide the button to OFF. The main gas flame and pilot flame should BOTH extinguish.
- Slide the button to REMOTE (the center position), then press the ON button on the transmitter to change the system to ON. The spark electrode should begin sparking to ignite the pilot. After the pilot is lit, the main gas valve should open and the main gas flame should ignite.

GENERAL INFORMATION

LEARNING TRANSMITTER TO RECEIVER

Each transmitter uses a unique security code. It will be necessary to press the LEARN button on the receiver to accept the transmitter security code upon initial use, if batteries are replaced, or if a replacement transmitter is purchased from your dealer or the factory. In order for the receiver to accept the transmitter security code, be sure the slide button on the receiver is in the REMOTE position; the receiver will **not** LEARN if the slide switch is in the ON or OFF position. The LEARN button is located on the front face of the receiver; inside the small hole labeled LEARN. Using a small screwdriver or end of a paperclip gently press and release the black LEARN button inside the hole. When you release the LEARN button the receiver will emit an audible "beep". After the receiver emits the beep press the transmitter ON button and release. The receiver will emit several beeps indicating that the transmitter's code has been accepted into the receiver.

The microprocessor that controls the security code matching procedure is controlled by a timing function. If you are unsuccessful in matching the security code on the first attempt, wait 1-2 minutes before trying again – this delay allows the microprocessor to reset its timer circuitry – and try up to two or three more times.

BATTERY LIFE

Life expectancy of the alkaline batteries in the transmitter should be at least 12 months. Check and replace all batteries annually. When the transmitter no longer operates the remote receiver from a distance it did previously (i.e., the transmitter's range has decreased) or the remote receiver does not function at all, the batteries should be checked. It is important that the remote receiver batteries are fully charged and provides continuous output voltage of a least 5.3 volts. The length of the wire between the remote receiver and gas valve directly affects the operating performance of the remote system. The longer the wire, the more battery power is required to deliver signals between the remote receiver and the gas valve. Recommended length is no longer than 20 feet. The transmitter should operate with as little as 5.3 volts battery power.

TROUBLE SHOOTING

If you encounter problems with your fireplace system, the problem may be with the fireplace itself or it could be with the SKYTECH remote. Review the fireplace manufacturer's operation manual to make sure all connections are properly made. Then check the operation of the SKYTECH remote in the following manner:

- Make sure the batteries are correctly installed in the RECEIVER. One reversed battery will keep receiver from operating properly.
- Check battery in Transmitter to make sure contacts are touching (+) and (-) ends of battery.
- Be sure RECEIVER and Transmitter are within 20 to 25-feet of operating range.
- Keep RECEIVER from temperatures exceeding 130^o F. Battery life shortened when ambient temperatures are above 130^o F.
- If RECEIVER is installed in tightly enclosed metal surround, the operating distance will be shortened.

SPECIFICATIONS

BATTERIES: Transmitter 6V – 4ea. AAA 1.5 Alkaline
Remote Receiver 6V –4ea. AA 1.5 Alkaline
Operating Frequency: 303.875MHZ

FCC ID No.'s: transmitter K9L5001;
Canadian ISC ID No.'s: transmitter –2439A-5001;

FCC REQUIREMENTS

NOTE: THE MANUFACTURER IS NOT RESPONSIBLE FOR ANY RADIO OR TV INTERFERENCE CAUSED BY UNAUTHORIZED MODIFICATIONS TO THIS EQUIPMENT. SUCH MODIFICATIONS COULD VOID THE USER'S AUTHORITY TO OPERATE THE EQUIPMENT.

FOR TECHNICAL
SERVICE, CALL:

U.S. INQUIRIES
888/672-8929 or
260/459-1703

CANADIAN INQUIRIES
877/472-3923

Website: skytechsystem.com

MANUFACTURED EXCLUSIVELY FOR SKYTECH II, INC

Limited Lifetime Warranty

SKYTECH II warrants the SKYTECH REMOTE CONTROL SYSTEM for a Limited Lifetime of the original owner of this system. This warranty is not transferable to another person it is for the original purchaser of the product. Should any part fail because of defective workmanship or material from the original date of purchase. SKYTECH II will repair or, at SKYTECH II option, replace the defective parts.

Replacement parts will be available at no charge for the first (5) five years of this warranty, and will be available at market cost for the Lifetime of the product to that original owner. If SKYTECH II does not have the parts for an individual model, then a replacement SYSTEM will be provided. At no charge for the first (5) five years and sold at market cost for the Lifetime of that product to the original owner.

The Owner must provide a bill of sale, cancelled check, or payment record should be kept to verify purchase date and establish warranty period. Travel, diagnostic cost, service labor to repair the defective SYSTEM, and freight charges on warranty parts to and from the factory will be the responsibility of the owner. SKYTECH will not be responsible for labor charges and/or damage incurred in installation, repair, replacement, or for incidental or consequential damages. Batteries and any damage caused by them are not covered by them are not covered by this warranty.

This warranty does not cover claims, which do not involve defective workmanship or materials.

Damage to the SYSTEM caused by accident, misuse, abuse, or installation error, whether performed by a contractor, Service Company, or owner, is not covered by this warranty. Modification of the SKYTECH product will void this warranty.

IN NO EVENT SHALL SKYTECH BE LIABLE FOR INCIDENTAL AND CONSEQUENTIAL INCLUDING THE IMPLIED WARRANTIES OF MERCHANTABILITY AND FITNESS, ARE LIMITED TO THE DURATION OF THIS WRITTEN WARRANTY. THIS WARRANTY SUPERSEDES ALL OTHER ORAL OR WRITTEN WARRANTIES.

Some States do not allow the exclusion or limitation of incidental and consequential damages or limitation on how long an implied warranty lasts, so the above limitation may not apply to you. This warranty gives you specific rights and you may have other rights, which vary from state, province, and nation.

How to Obtain Service:

Contact SKYTECH II or your SKYTECH Dealer direct with the following information:

- Name, Address, Telephone Number of Owner
- Date of Purchase, Proof of Purchase
- Model Name, Date Code

Any relevant information or circumstances, e.g., installation, mode of operation when defect was noted.

Warranty claim process will start with all of this information. SKYTECH will reserve the right to physically inspect the product for defects, by authorized representatives.

Detach at this line for return to: Skytech II 9230 Conservation Way, Fort Wayne, IN 46809 Telephone: (888) 672-8929

Purchase Date: _____ Model: _____ Date Code: _____

Purchased From: _____ Date: _____

Customer Name _____ Number of Santa's Helpers _____

Address _____

City _____ State/Prov. _____ Zip/Postal Code _____

Credit Card Number _____ Expiring Date _____

(Visa and MasterCard Only) See other side for a special offer for all Remote control Customers